

SINGER
148-5

LIST OF PARTS



MACHINE No. 148-5

INDEX

	PAGE
ACCESSORIES.....	20
BELT GUARD.....	20
FOOT LIFTER PARTS.....	20
IRON BASE.....	19
MACHINE No. 148-5.....	7
NUMERICAL LIST OF PARTS.....	23
PARTS REQUIRED TO CHANGE GAUGE OF MACHINE.....	22
THREAD UNWINDER.....	21

From the library of Diamond Needle Corp

INSTRUCTIONS FOR ORDERING

In ordering from this list, use **ONLY** the part NUMBER in the **FIRST** column.

The number stamped on a Sewing Machine part is in every case the number of the single part only.

Every combination of parts sent out as such has its specific number, which, although not stamped on the parts, must be used when ordering the combination.

Each number always indicates the **SAME PART** in whatever list it appears, or for whatever machine.

The letters after some of the numbers indicate the style of finish only, as follows:

- A—Hardened, Polished, Nickel Plated and Buffed
- B—Polished, Nickel Plated and Buffed
- C—Hardened Only
- D—Polished Only
- E—Soft, Not Polished
- F—Hardened and Polished
- H—Blued
- J—Nickel Plated Only
- K—Hardened and Nickel Plated
- L—Brass Plated
- M—Oxidized
- N—Japanned, Dull
- P—Japanned, Bright
- R—Merlized
- T—Copper Plated
- T. A.—Hardened, Polished, Copper and Nickel Plated and Buffed
- T. B.—Copper and Nickel Plated and Polished
- T. J.—Copper and Nickel Plated Only
- T. K.—Hardened, Copper and Nickel Plated
- T. M.—Copper Plated and Oxidized
- T. L.—Copper and Brass Plated
- U—Zinc Plated
- V—Silver Plated
- W—Polished and Nickel Plated
- Z—Chromium Plated
- Z. B.—Polished, Nickel Plated, Buffed and Chromium Plated
- Z. J.—Nickel and Chromium Plated

These letters **MUST BE USED** when they appear in the list; and **AFTER** the number **as** in the list.

In this series:

- 1 to 1500 and 50001 to 51500 are Screw Numbers
- 1501 to 1800 and 51501 to 51800 are Nut Numbers
- 1801 to 2000 and 51801 to 52000 are Roller Numbers
- 2001 to 50000 and 52001 and upward are numbers of Machine Parts

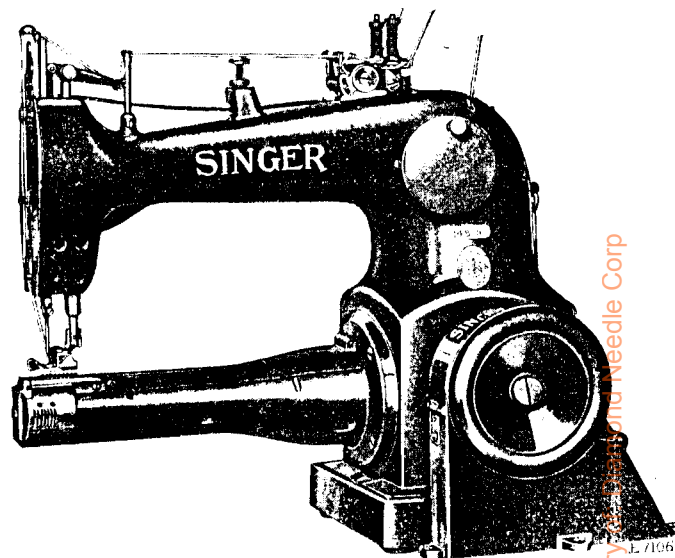
The figures in the second column refer only to the plates, illustrating the parts, and are **NOT TO BE USED** in ordering.

Parts marked with an asterisk (*) are furnished only when repairs are made at factory.

When ordering parts which differ as to **Gauge** (the distance between seams) the Gauge, as well as the **Number must be given** on order.

LIST OF PARTS COMPLETE

FOR



MACHINE No. 148-5

FOR SEAM COVERING ON KNIT GOODS, UNDERWEAR, ETC.
TWO NEEDLES ONE LOOPER, GAUGES 1/8, 1/6 AND 1/4
INCHES. DROP FEED, FOOT LIFTER.

FORMERLY 148 SV 3 MACHINE

NO.	PLATE	NAME
*128001	----	Arm.....
54913	9119	“ Back Cover.....
54914	----	Arm Back Cover complete, Nos. 1538D, 50223D, 54913, 54915, 54916 and two 1443D.....
54915	9101	Arm Back Cover Latch with 911E.....
50223D	9117	“ “ “ “ Hinge Screw....
	911E	9101 “ “ “ “ Screw Stud....
1538D	9101	“ “ “ “ “ “ Thumb Nut.....
54916	9101	Arm Back Cover Spring.....
	1443D	9101 “ “ “ “ Screw.....
54897	9101	“ Oil Cup.....

From the library of the Singer Sewing Machine Corp.

NO. PLATE	NAME
175E 9102	Cylinder Rock Shaft Connection Cap (small) Screw.....
128021 9141	Cylinder Rock Shaft Connecting Rod complete, Nos. 1722E, 1723E, 128022, 128025 and 128026.....
128022 —	Cylinder Rock Shaft Connecting Rod (rod only).....
50730c 9102	Cylinder Rock Shaft Connecting Rod Ball Screw Stud (lower).....
1664E 9118	Cylinder Rock Shaft Connecting Rod Ball Screw Stud (lower) Nut.....
50731c 9102	Cylinder Rock Shaft Connecting Rod Ball Screw Stud (upper).....
1597E 9118	Cylinder Rock Shaft Connecting Rod Ball Screw Stud (upper) Nut.....
*128023 —	Cylinder Rock Shaft Connecting Rod Cap (lower).....
171E 9117	Cylinder Rock Shaft Connecting Rod Cap (lower) Screw.....
*54613 —	Cylinder Rock Shaft Connecting Rod Cap (upper).....
171E 9117	Cylinder Rock Shaft Connecting Rod Cap (upper) Screw.....
*128024 —	Cylinder Rock Shaft Connecting Rod End Bearing (lower).....
*55032 —	Cylinder Rock Shaft Connecting Rod End Bearing (upper).....
125601 —	Cylinder Rock Shaft Connecting Rod End Bearing (upper) 55032 with 54613 and two 171E.....
128025 —	Cylinder Rock Shaft Connecting Rod Head (lower) Nos. 50730c, 128023, 128024 and two 171E.....
128026 —	Cylinder Rock Shaft Connecting Rod Head (upper) Nos. 217D, 50731c, 55034 and 125601.....
1722E 9122	Cylinder Rock Shaft Connecting Rod Nut (lower).....
1723E 9122	Cylinder Rock Shaft Connecting Rod Nut (upper).....
55034 9101	Cylinder Rock Shaft Connecting Rod Position Plate.....
217D 9117	Cylinder Rock Shaft Connecting Rod Position Plate Screw.....
128027 —	Cylinder Rock Shaft Eccentric.....
50589c 9109	“ “ “ “ Regulating Screw.....

NO. PLATE	NAME
198D 9109	Cylinder Rock Shaft Eccentric Set Screw
134D 9117	“ Screw.....
128199 9122	“ Thread Eyelet.....
128200 9122	“ “ “ Thread Guard
662D 9122	“ “ “ “ “ Screw.....
1402D 9117	Cylinder Thread Eyelet Screw.....
128030 9102	“ “ Guard.....
1302D 9118	“ “ “ Screw.....
128031 9103	“ “ Tube.....
128032 9103	“ Top Cover (back).....
54664 9109	“ “ “ “ Hinge Pin
460c 9118	“ “ “ “ “ Set Screw.....
128033 9103	Cylinder Top Cover (front) with 233D and 128034.....
391D 9118	Cylinder Top Cover (front) Screw.....
128034 9109	“ “ “ “ Spring.....
233D 9117	“ “ “ “ “ Screw.....
128035 9141	Face Plate.....
128036 —	Face Plate complete, Nos. 621D, 55184 and 128035.....
46111 9102	Face Plate Pin.....
55184 9101	“ “ Thread Guide.....
621D 9118	“ “ “ “ Screw.....
286D 9118	“ “ Thumb Screw.....
50732c 9117	Feed Adjusting Screw (eccentric).....
1735J 9118	“ “ “ Nut.....
128278 9144	“ Dog, 13 teeth (16 teeth to the inch)
NOTE: When ordering No. 128278 state gauge required.	
50128c 9117	Feed Dog Screw.....
128038 9112	“ Connecting Rod with 128039 and two 896E.....
*128039 —	Feed Connecting Rod Cap.....
896E 9117	“ “ “ “ Screw.....
*128040 —	“ Eccentric.....
128041 9109	Feed Eccentric (adjustable) complete, Nos. 198D, 50589c, 128027, 128040 and 128174.....
*128174 —	Feed Eccentric Body with two 1143c...
1143c 9109	“ “ “ Set Screw.....
128042 9109	“ Lifting Eccentric with two 462c...
128122 —	“ “ “ 128042 with 54953
462c 9118	“ “ “ Set Screw.....
128043 9112	“ “ Lever.....

NO.	PLATE	NAME
54953	9141	Feed Lifting Lever Connecting Rod with 54940 and two 896E.....
*54940	—	Feed Lifting Lever Connecting Rod Cap
896E	9117	" " " " " " " " Screw.....
50997c	9117	Feed Lifting Lever Connecting Rod Hinge Screw (eccentric).....
1722E	9122	Feed Lifting Lever Connecting Rod Hinge Screw Nut.....
128044	9102	Feed Lifting Lever Hinge Pin.....
452c	9122	" " " " " " Set Screw
128045	9109	" Regulator.....
54958	9102	" " Friction Spring.....
128046	9109	" " Pawl with two 453c....
128047	9141	" " " Lever with 448c..
448c	9145	" " " " Set Screw..
128048	9102	" " " " Stud.....
42833	9102	" " " " " Spring
453c	9142	" " " " Set Screw.....
128049	9102	" " " Shaft.....
128050	9143	" Rod.....
128051	9102	" " Connecting Link (left).....
128052	9102	" " " " (right).....
50733c	9117	" " " " Hinge Screw
1735j	9118	" " " " " " " " Nut.....
128053	9122	Feed Rod Hinge Bracket with 50150c..
128054	9142	" " " " Hinge Pin....
50150c	9142	" " " " " " " " Set Screw.....
128055	9102	Feed Rod Hinge Pin.....
50150c	9142	" " " " Set Screw.....
*128334	—	Hand Wheel.....
128335	9137	" " and Pulley, Nos. 128334, 128337 and two 50084c.....
50084c	9122	Hand Wheel and Pulley Set Screw.....
128336	9143	" " " " Shaft.....
128340	—	" " " " " " 128336 with 54616.....
54968	9112	Hand Wheel and Pulley Shaft Bushing (right).....
41128	9142	Hand Wheel and Pulley Shaft Bushing (right) Oil Pad (braided cotton).....
888c	9118	Hand Wheel and Pulley Shaft Bushing (right) Set Screw.....
128388	9142	Hand Wheel and Pulley Shaft Flanged Bushing (left).....

NO.	PLATE	NAME
42365	9142	Hand Wheel and Pulley Shaft Flanged Bushing (left) Oil Pad (braided cotton)
445c	9122	Hand Wheel and Pulley Shaft Flanged Bushing (left) Set Screw.....
150b	9142	Hand Wheel and Pulley Shaft Screw....
54970	9101	" " " " " Washer..
128283	9145	Loop Guard (needle thread).....
128284	9145	" " " " " Holder with 51094c, 51095c and two 1607E.....
51095c	9145	Loop Guard (needle thread) Holder Adjusting Screw (lower).....
1607E	9145	Loop Guard (needle thread) Holder Adjusting Screw (lower) Lock Nut.....
51094c	9145	Loop Guard (needle thread) Holder Adjusting Screw (upper).....
1607E	9145	Loop Guard (needle thread) Holder Adjusting Screw (upper) Lock Nut.....
128285	9145	Loop Guard (needle thread) Holder Bracket.....
128286	—	Loop Guard (needle thread) Holder Bracket 128285 with 233D, 1161J, 50425D, 128283, 128284 and 128287....
185D	9117	Loop Guard (needle thread) Holder Bracket Screw.....
50425D	9145	Loop Guard (needle thread) Holder Hinge Screw.....
128287	9145	Loop Guard (needle thread) Holder Spring.....
233D	9117	Loop Guard (needle thread) Holder Spring Screw.....
1161J	9145	Loop Guard (needle thread) Screw....
128405	9142	Looper.....
128406	9142	" Carrier with 1454c.....
1454c	9142	" " Clamping Screw.....
197D	9142	" Screw.....
54708	9112	Needle Bar (hollow).....
128281	—	Needle Bar complete, Nos. 54708 and 128282.....
54710	9142	Needle Bar Bushing (lower).....
563c	9118	" " " " Set Screw..
54710	9142	" " " (upper).....
563c	9118	" " " " Set Screw..
*54711	9145	" " Connecting Link.....
128126	—	" " " " " 54711 with 54712 and 128118.....
54712	9145	Needle Bar Connecting Link Hinge Stud

NO.	PLATE	NAME
1520j	9118	Needle Bar Connecting Link Hinge Stud Nut.....
128117	9145	Needle Bar Connecting Stud with 207E.
207E	9145	" " " " Clamping Screw.....
128118	---	Needle Bar Connecting Stud complete, Nos. 220D, 1332D, 54716, 128117, 128119 and 128120.....
128119	9145	Needle Bar Thread Retainer.....
128120	9145	" " " " Bracket
220D	9117	" " " " " Screw.....
54716	9145	Needle Bar Thread Retainer Spring.....
1332D	9145	" " " " " Screw
128282	9145	" Clamp with two 209F.....
128407	---	" Guard.....
128408	---	" " Holder.....
128409	---	" " " 128408 with 50225J and 128407.....
185D	9117	Needle Guard Holder Screw.....
50225J	---	" " Screw.....
209F	9145	" Set Screw.....
55084	9146	Presser Bar (lower).....
128064	9146	" " " Bushing.....
563C	9118	" " " " Set Screw..
128065	9146	" " (upper).....
128066	9146	" " " Guide Bracket with 440c.....
440c	9146	Presser Bar (upper) Guide Bracket Set Screw.....
128067	9146	Presser Bar Connecting Bracket with 448c and 453c.....
448c	9145	Presser Bar Connecting Bracket Set Screw (long).....
453c	9142	Presser Bar Connecting Bracket Set Screw (short).....
128068	9146	Presser Bar Lifter.....
128069	9146	" " " Connecting Link
50116F	9117	" " " " " Hinge Screw (long).....
108F	9117	Presser Bar Lifter Connecting Link Hinge Screw (short).....
50415c	9117	Presser Bar Lifter Hinge Screw.....
2269	9146	" " " Stop Pin (lower)....
2049	9146	" " " " " (upper)....
128070	9103	" " Lifting Lever.....
128071	9112	" " " " Extension

NO.	PLATE	NAME
161c	9117	Presser Bar Lifting Lever Extension Screw.....
866D	9117	Presser Bar Lifting Lever Hinge Screw.
184D	9145	" " " " Stop Screw..
128072	9103	" " Spring (flat).....
54722	9146	" " " Stud.....
128288	---	" Foot.....
128289	---	" " Compensating Plate with 128308.....
128308	9144	Presser Foot Compensating Plate Pin...
14058	9144	" " " " Spring
128290	9144	" " " " " Cap.....
337D	9131	Presser Foot Compensating Plate Spring Cap Screw.....
34318	9144	Presser Foot Compensating Plate Stop Pin.....
128291	9144	Presser Foot (compensating) complete, Nos. 337D, 34318, 128288, 128290 and two each 14058 and 128289.....

NOTE: When ordering No. 128291 state gauge required

190D	9117	Presser Foot Screw.....
50132w	9118	Pressure Regulating Thumb Screw.....
1543w	9118	" " " " Lock Nut.....
*128337	---	Pulley, 27/8 in. diam.....
128292	9145	Seam Guide.....
1174J	9145	" " Screw.....
128075	9147	Tension (under thread) Bracket.....
176D	9117	" " " " Screw..
2102	9131	" " " Disc.....
51570c	9131	" " " Regulating Thumb Nut.....
128076	9147	Tension (under thread) Releaser.....
233D	9117	" " " " Adjusting Screw.....
50076D	9117	Tension (under thread) Releaser Hinge Screw.....
32572	9131	Tension (under thread) Releasing Disc..
128077	9103	" " " " Lever
63824	9131	" " " " " Spring.....
1144D	9117	Tension (under thread) Releasing Lever Spring Screw.....
128078	9131	Tension (under thread) Releasing Pin...

NO.	PLATE	NAME
50326c	9131	Tension (under thread) Screw Stud
59539	—	“ “ “ “ “
		50326c with 51570c.....
59534	9131	Tension (under thread) Spring.....
59537	9131	“ “ “ “ Bushing
		(large).....
59538	9131	Tension (under thread) Spring Bushing
		(small).....
17547	9131	Tension (under thread) Thread Guide...
128079	9103	“ (upper thread) Bracket with two
		447c.....
376D	9118	Tension (upper thread) Bracket Screw...
128080	9147	“ “ “ “ Thread
		Eyelet (double).....
330D	9118	Tension (upper thread) Bracket Thread
		Eyelet Screw.....
128081	9131	Tension (upper thread) Bracket Thread
		Eyelet Screw Washer.....
2102	9131	Tension (upper thread) Disc.....
51570c	9131	“ “ “ “ Regulating
		Thumb Nut.....
32572	9131	Tension (upper thread) Releasing Disc...
128078	9131	“ “ “ “ Pin...
54989	9147	“ “ “ “ Shaft
128082	9147	“ “ “ “ “
		Crank with 452c.....
54873	9147	Tension (upper thread) Releasing Shaft
		Crank Link.....
110c	9117	Tension (upper thread) Releasing Shaft
		Crank Link Hinge Screw.....
452c	9122	Tension (upper thread) Releasing Shaft
		Crank Set Screw.....
128165	9121	Tension (upper thread) Releasing Shaft
		Spring.....
316c	9118	Tension (upper thread) Releasing Shaft
		Stop Screw.....
1547J	9118	Tension (upper thread) Releasing Shaft
		Stop Screw Nut.....
50326c	9131	Tension (upper thread) Screw Stud
59539	—	“ “ “ “ “
		50326c with 51570c.....
59536	9131	Tension (upper thread) Spring.....
59537	9131	“ “ “ “ Bushing
		(large).....
59538	9131	Tension (upper thread) Spring Bushing
		(small).....
17547	9131	Tension (upper thread) Thread Guide...

NO.	PLATE	NAME
128083	9143	Tension Releasing Arm with 51818.....
128084	9143	“ “ “ Connecting Rod
1521E	9118	“ “ “ “ “
		Nut.....
1131c	9117	Tension Releasing Arm Hinge Screw...
51818	9147	“ “ “ Roller and Screw
		Stud.....
128085	9145	Thread (under) Eyelet.....
620c	9118	“ “ “ Set Screw.....
128086	9147	“ “ Nipper Cam with 61121
		and two 465c.....
128087	—	Thread (under) Nipper Cam Oil Pad
		(felt).....
128088	—	Thread (under) Nipper Cam Oil Pad
		Holder.....
128089	9147	Thread (under) Nipper Cam Oil Pad
		Holder 128088 with 128087.....
465c	9146	Thread (under) Nipper Cam Set Screw...
128090	9147	“ “ “ Spring (lower)...
128293	9147	“ “ “ “ (upper)...
334D	9118	“ “ “ “ Screw...
128238	9148	“ “ Protector.....
228D	9147	“ “ “ Screw.....
128294	9148	“ “ Pull-off.....
226D	9117	“ “ “ Adjusting Screw
61121	9146	“ “ “ Position Pin...
128295	9148	“ “ “ Stripper.....
203D	9117	“ “ “ “ Screw...
128296	9148	“ “ Take-up with two 465c
		NOTE: When ordering No. 128296, state gauge
		required.
128243	9143	Thread (under) Take-up Frame.....
128298	—	Thread (under) Take-up Frame complete,
		Nos. 128105, 128243 and 128299.....
*128299	9143	Thread (under) Take-up Frame Cover
		with 50150c.....
128105	9148	Thread (under) Take-up Frame Cover
		Hinge Pin.....
50150c	9142	Thread (under) Take-up Frame Cover
		Hinge Pin Set Screw.....
1149D	9145	Thread (under) Take-up Frame Screw...
128246	9148	“ “ “ Knife.....
128247	9148	“ “ “ “ Holder
		with 465c.....
185D	9117	Thread (under) Take-up Knife Holder
		Screw.....

NO.	PLATE	NAME
465C	9146	Thread (under) Take-up Knife Set Screw
465C	9146	" " " Set Screw.....
128338	9148	" " " Stripper.....
128098	9148	" " " " Bracket
1364C	9117	" " " " " Screw.....
330D	9118	Thread (under) Take-up Stripper Screw
128081	9131	" " " " " Washer.....
128249	9148	Thread (under) Take-up Thread Guard with 220D.....
128297	9149	Thread (under) Take-up Thread Guard Bracket.....
1364C	9117	Thread (under) Take-up Thread Guard Bracket Screw.....
1137E	9118	Thread (under) Take-up Thread Guard Hinge Screw.....
128101	9148	Thread (under) Take-up Thread Guard Spring.....
335D	9118	Thread (under) Take-up Thread Guard Spring Screw.....
220D	9117	Thread (under) Take-up Thread Guard Stop Screw.....
128106	9149	Thread (upper) Controller.....
125564	9149	" " " " Lever with 50138F.....
54879	9143	Thread (upper) Controller Lever Connection.....
999F	9117	Thread (upper) Controller Lever Connection Hinge Screw (lower).....
999F	9117	Thread (upper) Controller Lever Connection Hinge Screw (upper).....
1700E	9118	Thread (upper) Controller Lever Connection Hinge Screw (upper) Nut....
125566	9149	Thread (upper) Controller Lever Hinge Stud.....
465C	9146	Thread (upper) Controller Lever Hinge Stud Set Screw.....
125567	9149	Thread (upper) Controller Lever Post with 465C.....
443C	9118	Thread (upper) Controller Lever Post Set Screw.....
50138F	9149	Thread (upper) Controller Set Screw...
128107	9149	" " " " Thread Guide
128108	9149	" " " " " Post.....

NO.	PLATE	NAME
175F	9102	Thread (upper) Controller Thread Guide Post Set Screw.....
226D	9117	Thread (upper) Controller Thread Guide Screw.....
128109	9149	Thread (upper) Check Spring (left)
2127	9149	" " " " " Adjusting Plate.....
226D	9117	Thread (upper) Check Spring (left) Adjusting Plate Screw.....
128110	9149	Thread (upper) Check Spring (right)
128111	9149	" " " " " Adjusting Plate.....
226D	9117	Thread (upper) Check Spring (right) Adjusting Plate Screw.....
128112	9101	Thread (upper) Check Spring Regulating Stud.....
447C	9118	Thread (upper) Check Spring Regulating Stud Set Screw.....
125568	9101	Thread (upper) Take-up.....
217D	9117	" " " " Screw.....
128300	9149	" " " " Stripper (left)
128301	9149	" " " " (right)
NOTE: When ordering No. 128301 state gauge required.		
128114	9101	Thread (upper) Take-up Stripper Bracket
1492D	9117	" " " " " Screw.....
226D	9117	Thread (upper) Take-up Stripper Screw
128302	9144	Throat Plate with 128303, 128304 and two 229D, for $\frac{1}{8}$ in. gauge, for 128278
128359	9144	Throat Plate with 128303, 128304 and two 229D, $\frac{3}{16}$ in. gauge, for 128278....
128360	9144	Throat Plate with 128303, 128304 and two 229D, for $\frac{1}{4}$ in. gauge, for 128278
128303	9144	Throat Plate Guide (left).....
128304	9144	" " " (right).....
229D	9117	" " " " Screw.....
1319F	9118	" " " " Screw.....

IRON BASE

NO.	PLATE	NAME
128116	9119	Machine Base with 304C, 307C, 448C, 1513J, 27795, two each 935D, 42088, 66707 and three wood screws 1 $\frac{1}{2}$ in. No. 12.....

NO.	PLATE	NAME
42088	9121	Machine Cushion (felt).....
935d	9121	“ “ “ Screw.....
66707	9121	“ “ “ Washer.....
301c	9121	“ “ “ Screw Centre (left).....
1513f	9121	“ “ “ “ Nut.....
307c	9140	“ “ “ (right).....
448c	9142	“ “ “ “ Set Screw
27795	9140	“ “ “ “ “ “ Washer.....

ACCESSORIES

NO.	PLATE	NAME
1407j	5563	Machine Thumb Screw, for 3 in. table..
1408j	5563	“ “ “ “ 2 in. table..
14063	9140	“ “ “ Spring.....
9842	9121	“ “ “ “ Washer..
120344	6375	Oiler (copper plated) with 120315.....
120345	6375	“ Spout, 5 in. long.....
26026	6375	Screw Driver (large).....
26485	6375	“ “ (small).....
120341	6375	Tweezers (curved).....
4822	6375	Wrench for 1521 and 1547.....
8908	6375	“ “ 1664, 1722 and 1723.....
8909	9140	“ “ 1513.....

BELT GUARD

NO.	PLATE	NAME
128171	9119	Belt Guard (lower).....
128172	9119	“ “ (upper).....
63505	9121	“ “ “ Hinge Pin.....
743382	9121	“ “ “ Lock Spring.....
2273	9121	“ “ “ “ “ Position Pin.....
331d	9118	Belt Guard (upper) Lock Spring Screw.
128173	—	Belt Guard complete, Nos. 331d, 2273, 63505, 128171, 128172, 743382 and three wood screws, 1 in. No. 10.....

FOOT LIFTER PARTS

NO.	PLATE	NAME
6439	—	Chain, 36 in. to 45 in., with 56864 and 56865.....

NOTE: When ordering No. 6439, give length required.

NO.	PLATE	NAME
4879	9121	Chain Connecting Link.....
56864	9121	“ Hook (large).....
56865	9121	“ “ (small).....
126249	9137	Treadle.....
4882	9121	“ Shaft.....
126250	9140	“ Spring.....
126251	9137	“ Stand.....
126252	9137	Treadle complete, Nos. 4882, 126249 to 126251 and two wood screws 1 in. No. 16.....

THREAD UNWINDER

FOR THREE SPOOLS

NO.	PLATE	NAME
225389	7165	Spool Rest (for one spool) with 201018c
225395	7165	“ “ (for two spools) with 201018c
225388	7165	“ “ Rod.....
200383c	9140	“ “ “ Set Screw.....
201018c	9140	“ “ “ Set Screw.....
202490	7165	“ “ Stand with 200383c.....
225391	7165	Thread Guide.....
201696j	9140	“ “ Lock Nut.....
225392	7165	“ “ Rod with 208e and 225393
208e	9117	“ “ “ Screw.....
225393	9140	“ “ “ Washer.....
225397	7165	Thread Unwinder complete, Nos. 201696j, 202490, 225388, 225389, 225392, 225395, three 225391 and wood screws 7/8 in. No. 12.....
27739	7234	Thread Cone (wood) for large cones....
225390	7234	“ “ “ Holder, for inverted cones

NOTE: Nos. 27739 and 225390 are used with, but not included in, 225397

Genuine Singer Needles and their Containers are marked with the Company's Trade Mark "SIMANCO." 1

Needles in Containers marked "For Singer Machines" are not Singer made needles. 2

PARTS REQUIRED TO CHANGE GAUGE OF MACHINE

NOTE: When ordering parts, the gauge required
MUST be stated on order

FOR $\frac{1}{8}$ INCH GAUGE

NO.	PLATE	NAME
128278	9144	Feed Dog, 13 teeth (16 teeth to the inch)
128282	9145	Needle Clamp with two 209F.....
128291	9144	Presser Foot (compensating) complete, Nos. 337D, 34318, 128288, 128290 and two each 14058 and 128289.....
128296	9148	Thread (under) Take-up with two 465C..
128301	9149	“ (upper) Take-up Stripper (right).
128302	9144	Throat Plate with 128303, 128304 and two 229D, for 128278.....

FOR $\frac{3}{16}$ INCH GAUGE

128278	9144	Feed Dog, 13 teeth (16 teeth to the inch)
128282	9145	Needle Clamp with two 209F.....
128291	9144	Presser Foot (compensating) complete, Nos. 337D, 34318, 128288, 128290 and two each 14058 and 128289.....
128296	9148	Thread (under) Take-up with two 465C..
128301	9149	“ (upper) Take-up Stripper (right).
128359	9144	Throat Plate with 128303, 128304 and two 229D, for 128278.....

FOR $\frac{1}{4}$ INCH GAUGE

128278	9144	Feed Dog, 13 teeth (16 teeth to the inch)
128282	9145	Needle Clamp with two 209F.....
128291	9144	Presser Foot (compensating) complete, Nos. 337D, 34318, 128288, 128290 and two each 14058 and 128289.....
128296	9148	Thread (under) Take-up with two 465C..
128301	9149	“ (upper) Take-up Stripper (right).
128360	9144	Throat Plate with 128303, 128304 and two 229D, for 128278.....

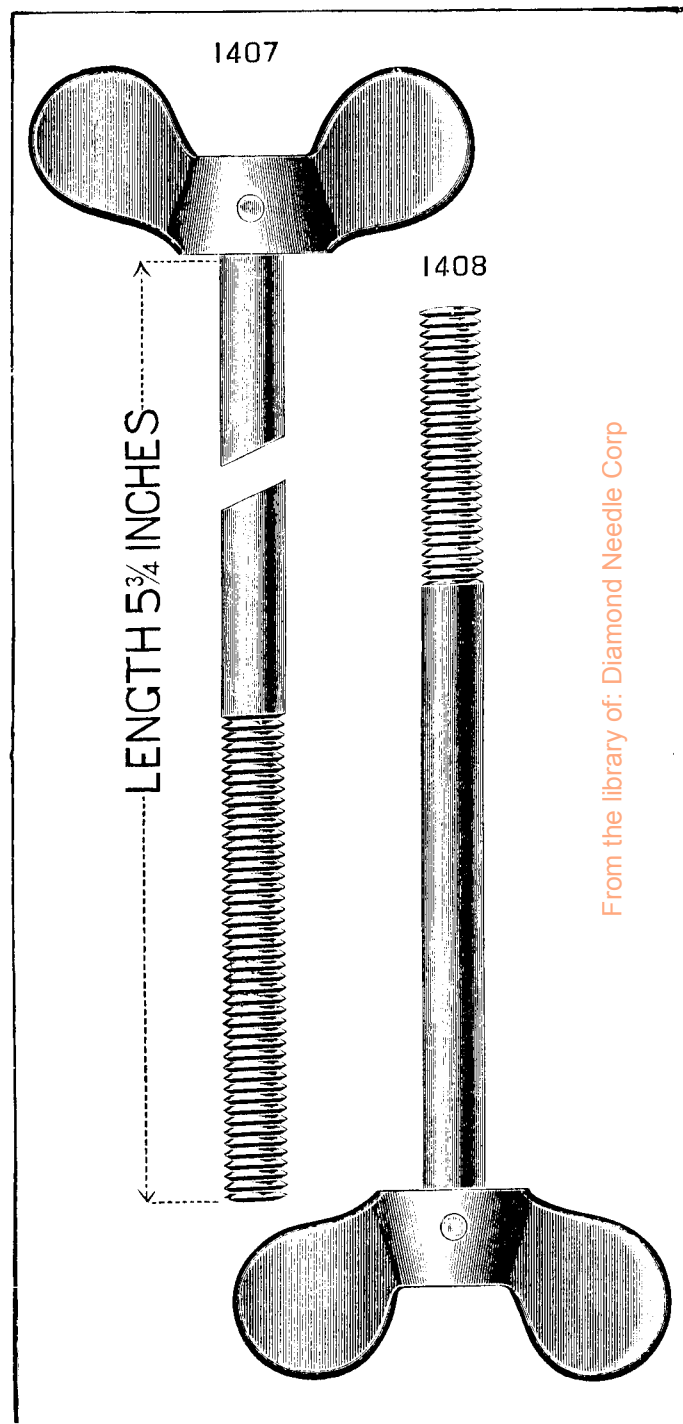


PLATE 6375—ONE-HALF SIZE

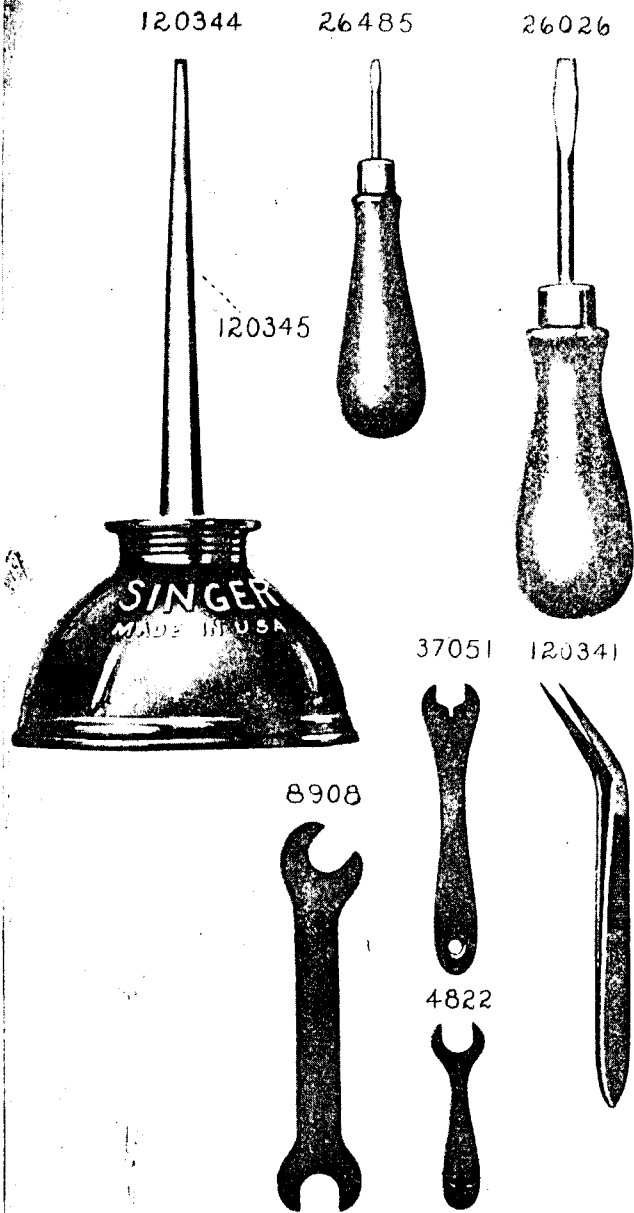


PLATE 7165—ONE-SIXTH SIZE

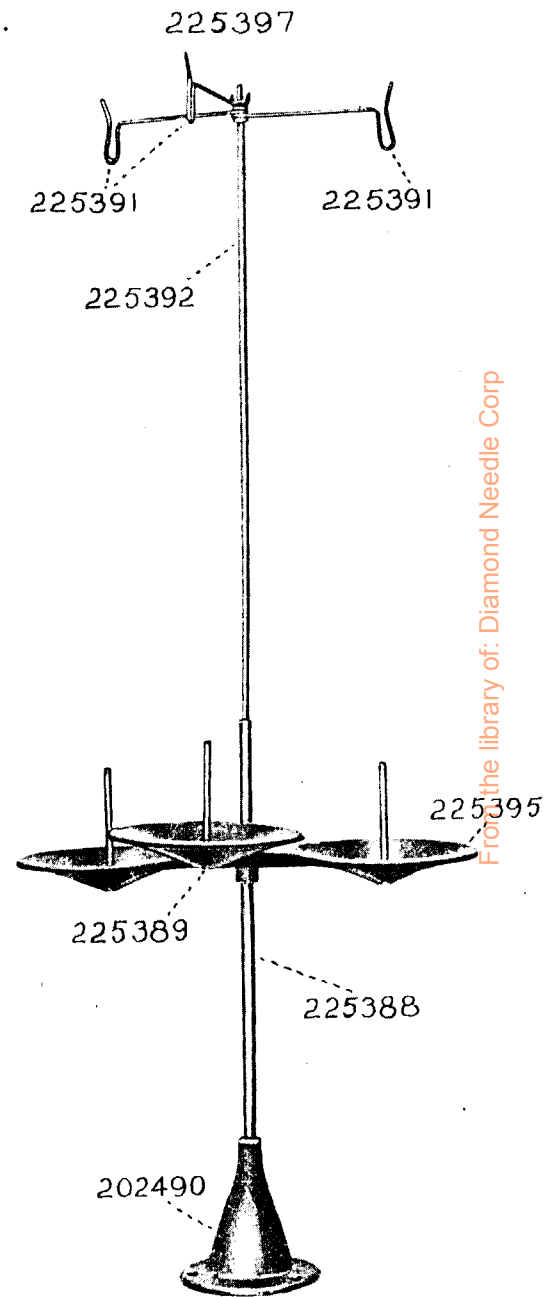
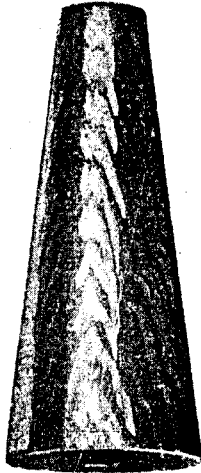


PLATE 7234—ONE-HALF SIZE

27739



225390

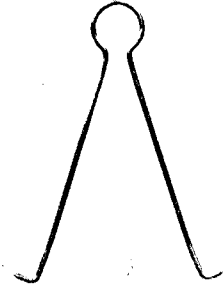


PLATE 9101—FULL SIZE

54915



911



1443



456



54916



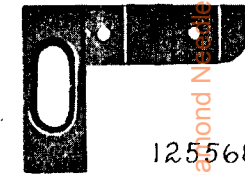
128003



54919



128114



128112

125568



1538



54921



128113

128149



54897



55034



54620



50729



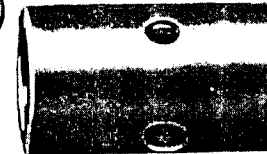
55184



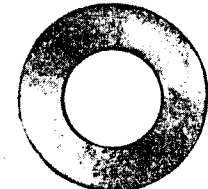
128013



128004



54970



from the library of the RAND Nucleo Corp

PLATE 9102—FULL SIZE

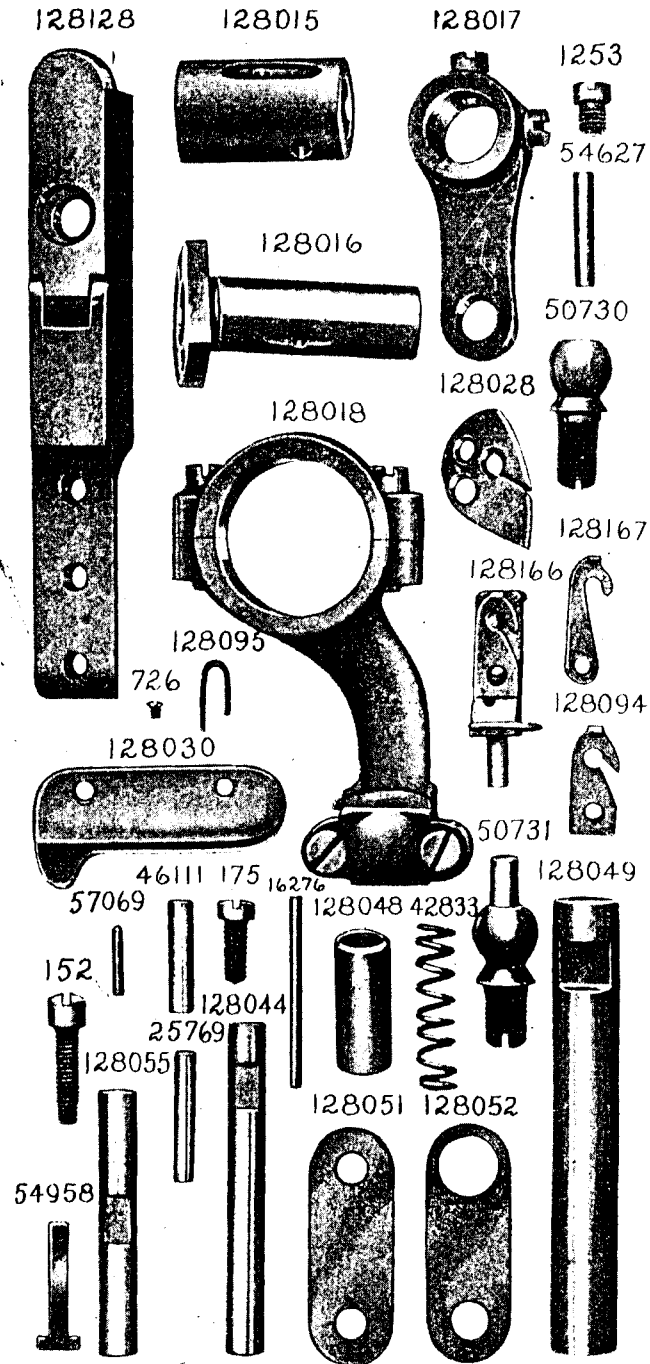


PLATE 9103—ONE-HALF SIZE

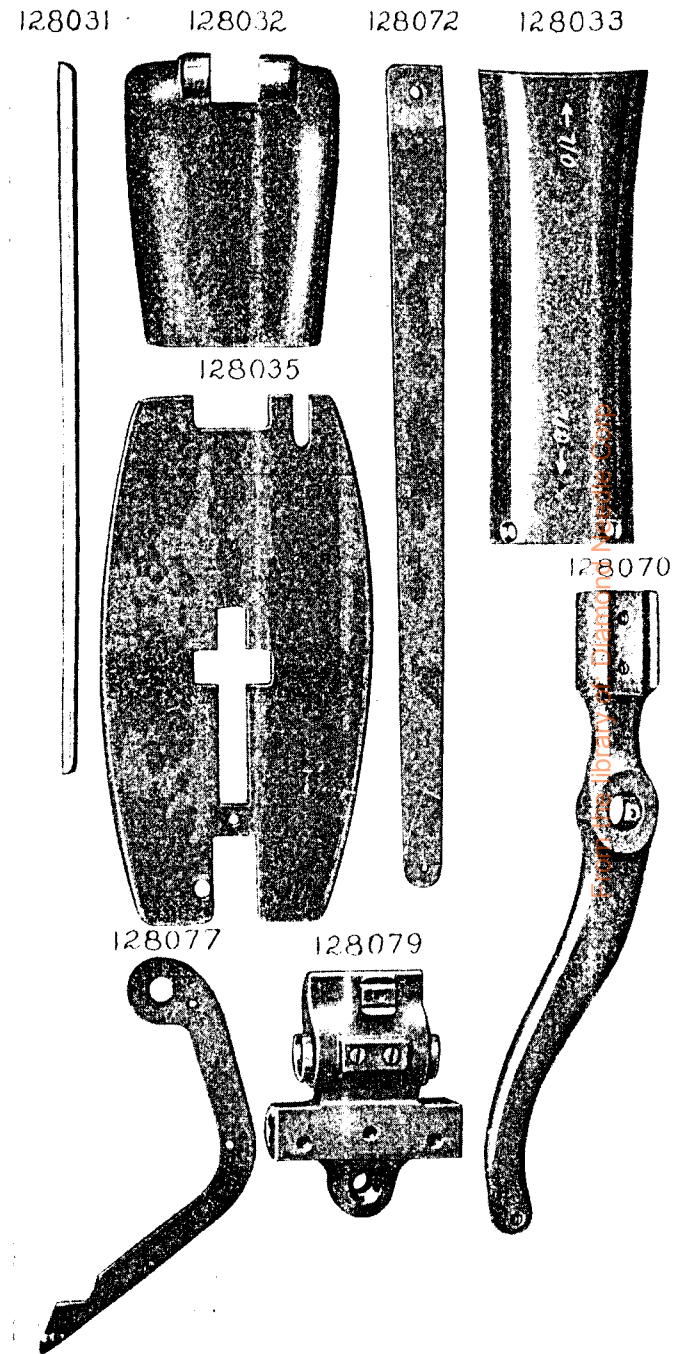
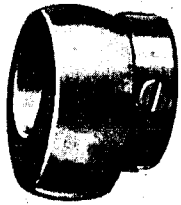


PLATE 9109—FULL SIZE

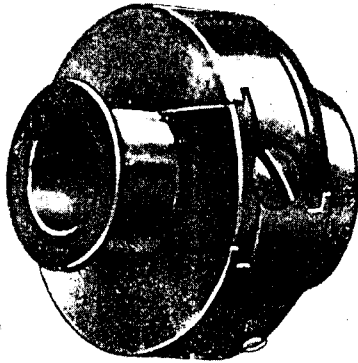
128042



54953



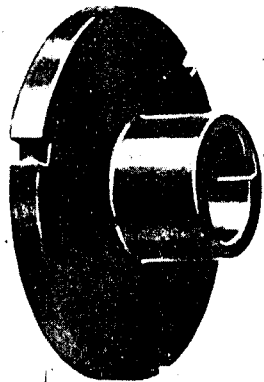
128041



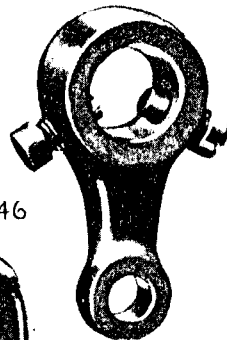
128034



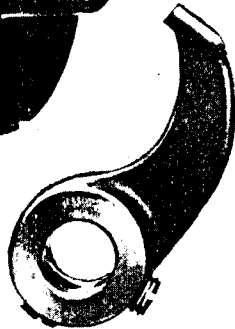
128045



128007



128046



54664



198



1143

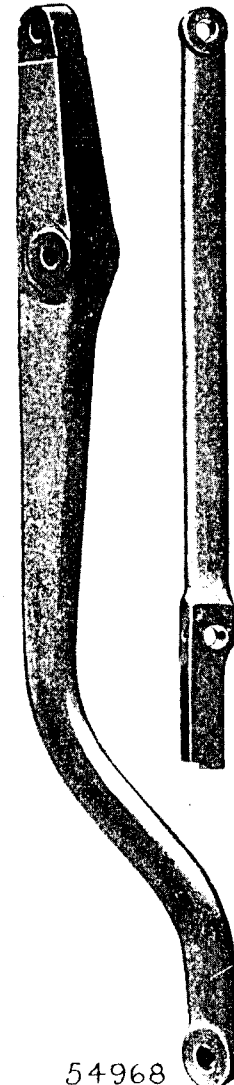


50589



PLATE 9112—ONE-HALF SIZE

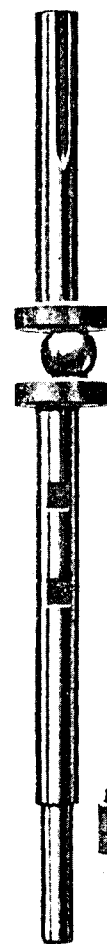
128043



128050



128056



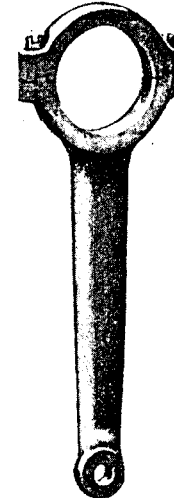
54708



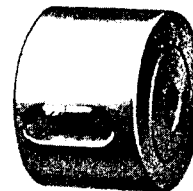
128071



128038



54968



From the library of: <http://www.egon.com>

PLATE 9117—FULL SIZE

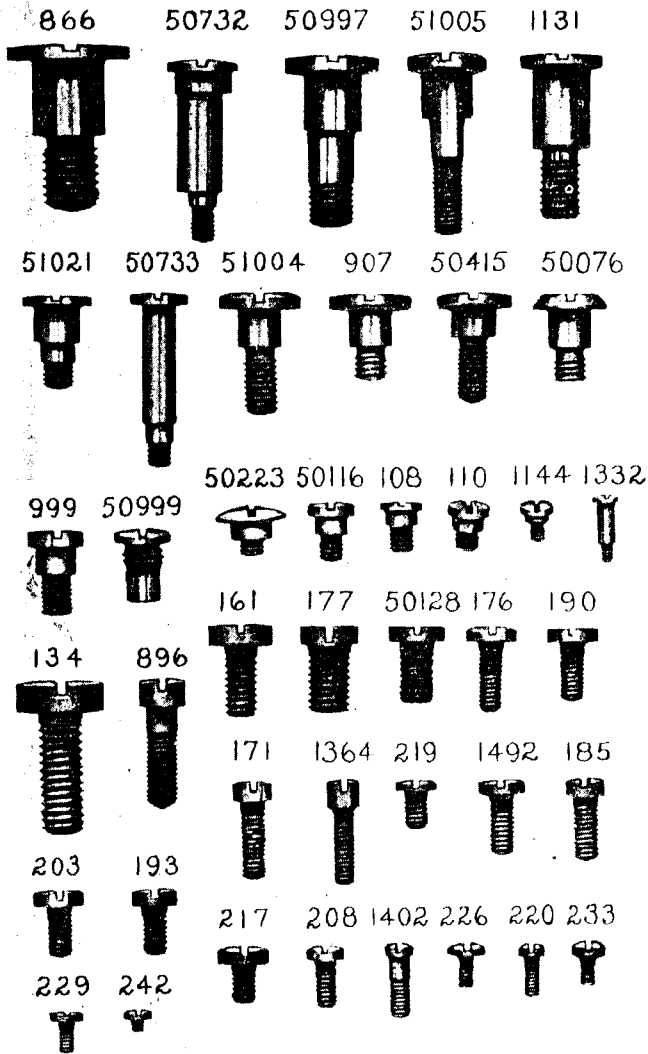


PLATE 9118—FULL SIZE

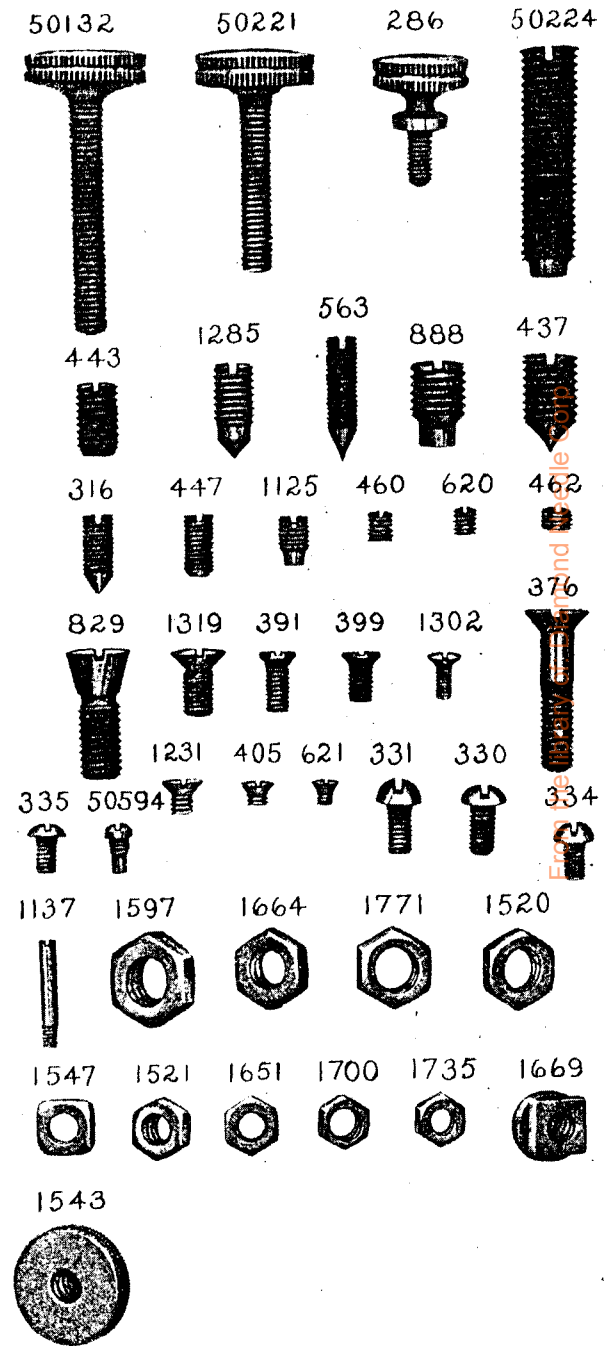


PLATE 9119—ONE-FOURTH SIZE

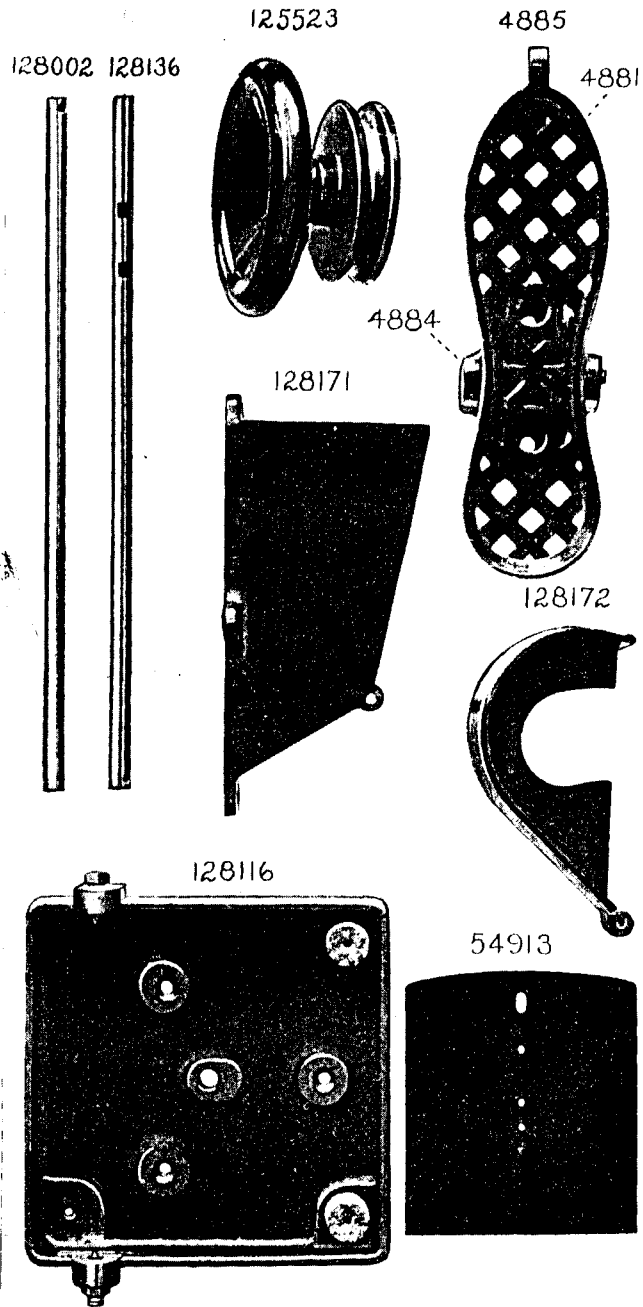
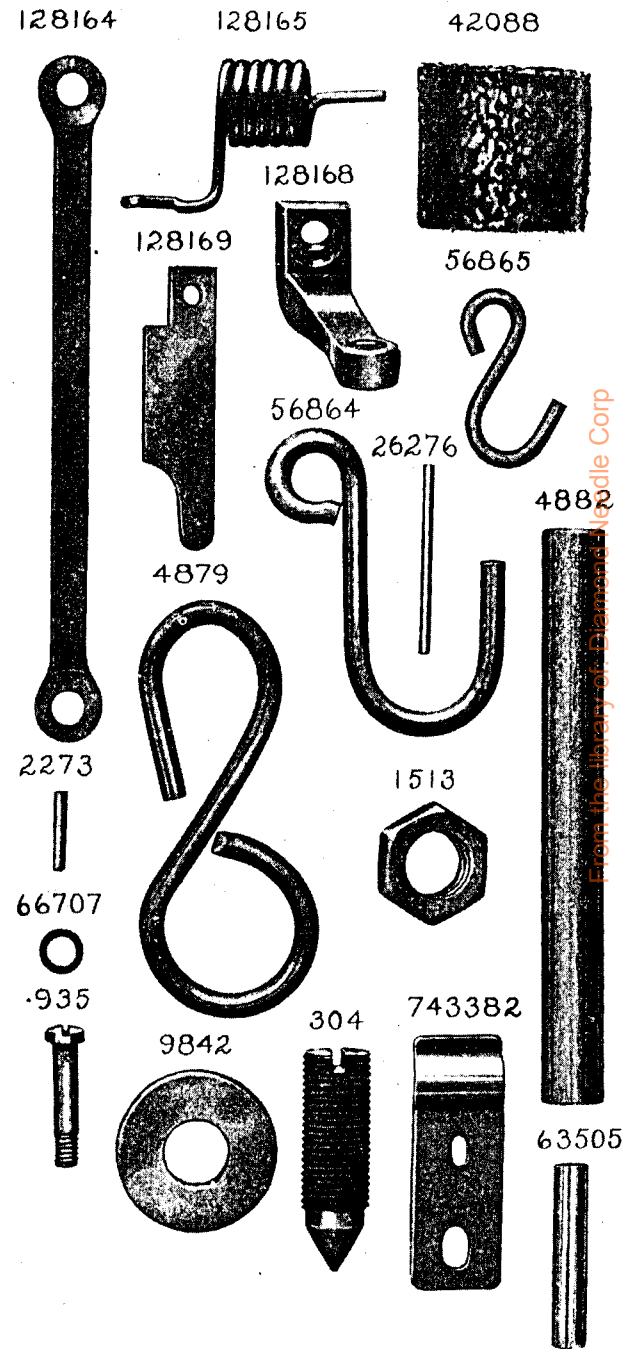


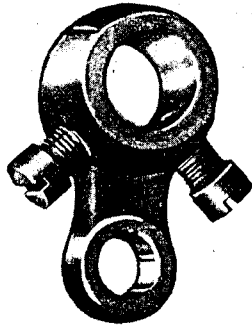
PLATE 9121—FULL SIZE



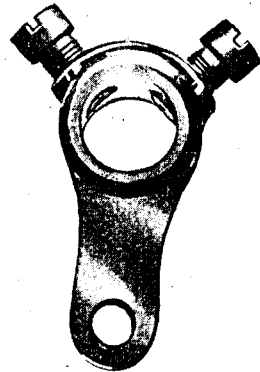
From the library of Diamond Needle Corp

PLATE 9122—FULL SIZE

128262



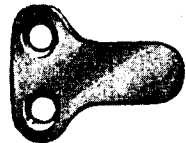
128006



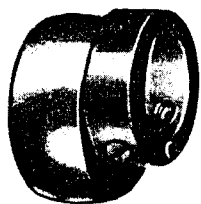
51043



128271



128203



128382



50084



67425



128199



1722



128200



1723



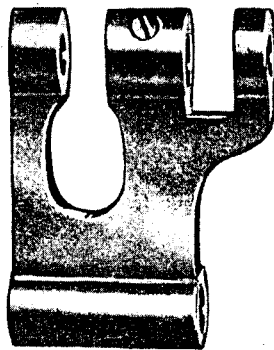
662



452



128053



445



664

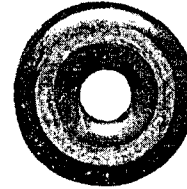


128390

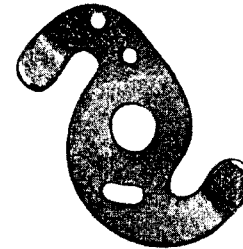


PLATE 9131—FULL SIZE

2102



128221



59534



128225



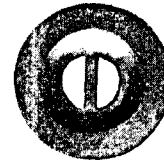
128081



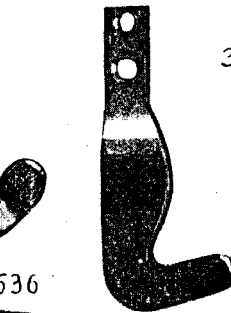
51034



32572



128222



59536



128078



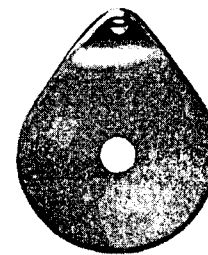
735



170



17547



337



63824



59537



128227



50326

59538



51570



128224



From the library

PLATE 9137—ONE-FOURTH SIZE

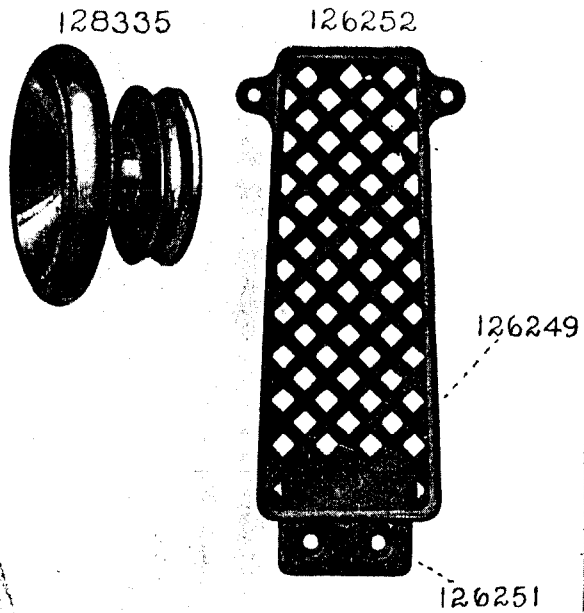
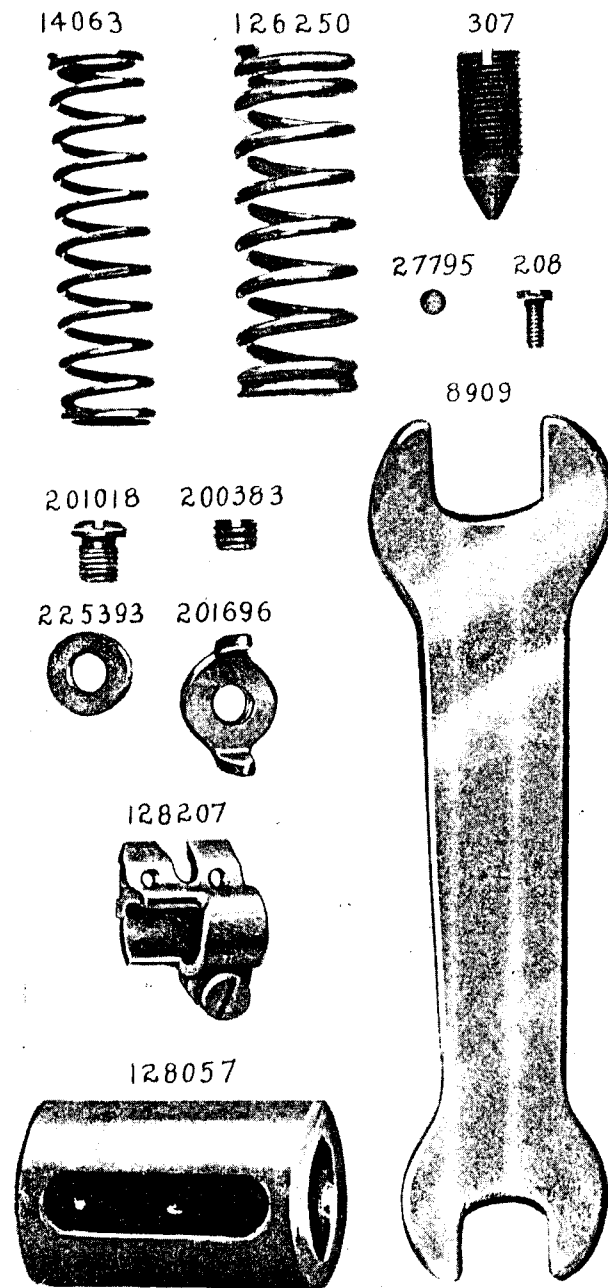


PLATE 9140—FULL SIZE



From the library of: Diamond Needle Corp

PLATE 9141—ONE-HALF SIZE

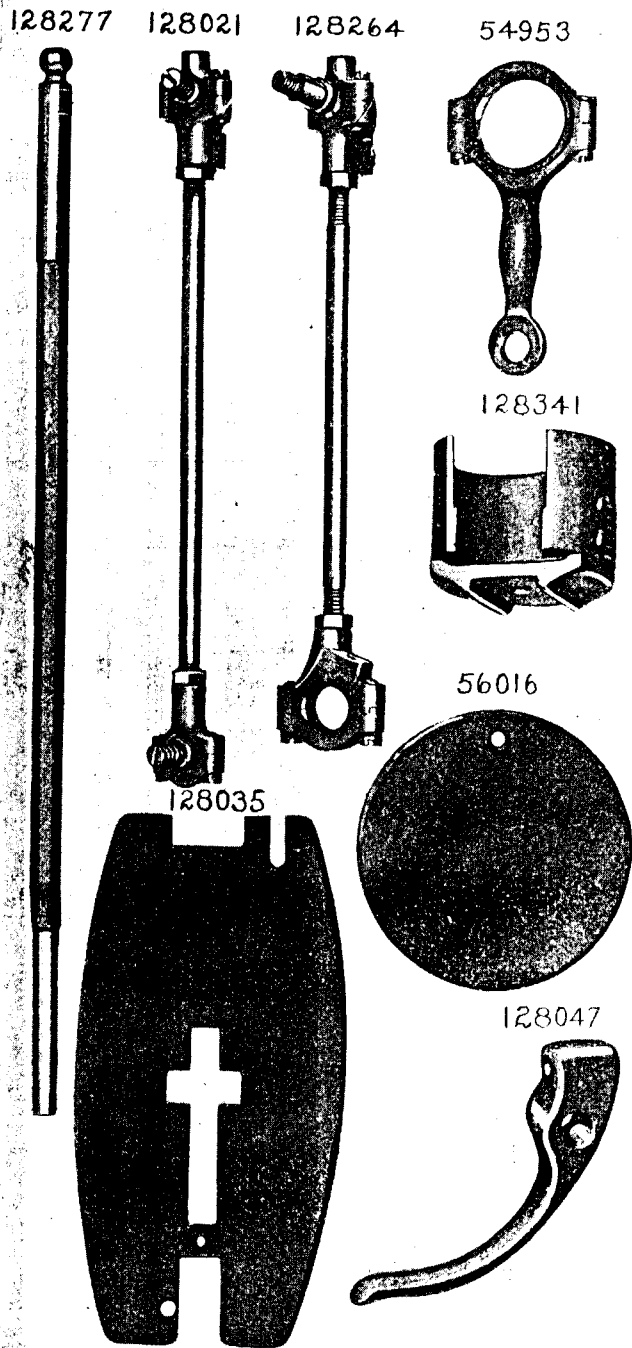
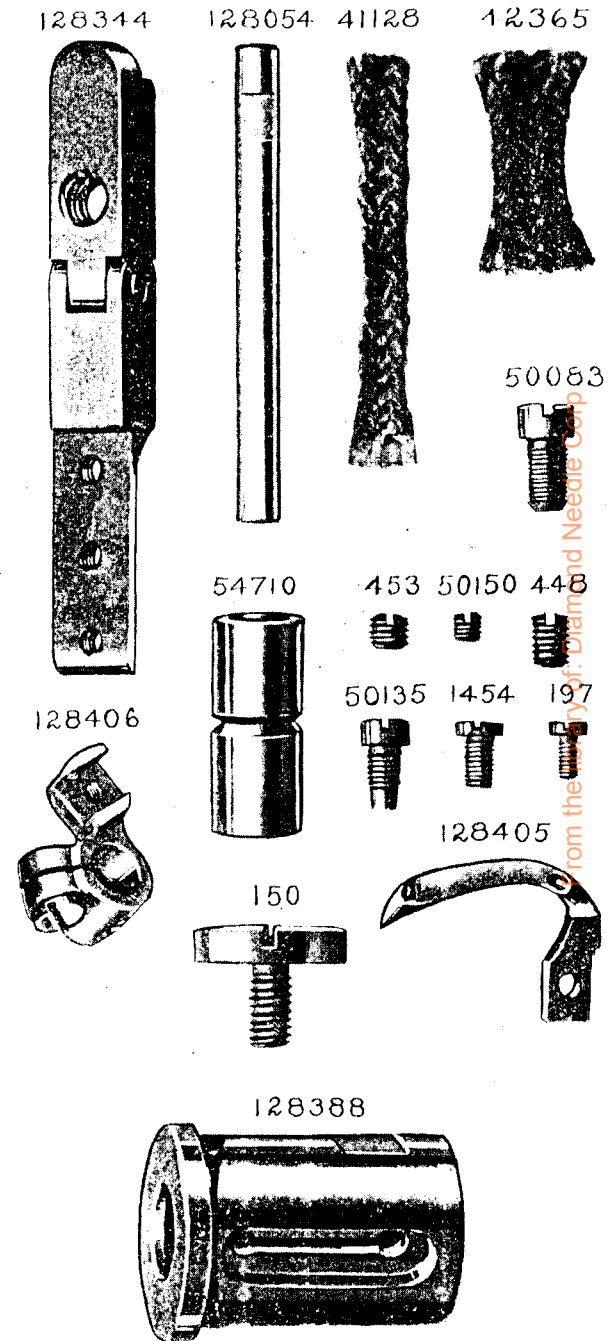


PLATE 9142—FULL SIZE



from the [Library of Diamond Needle Corp.](#)

PLATE 9143—ONE-HALF SIZE

128336 128084 128050 128083 54879

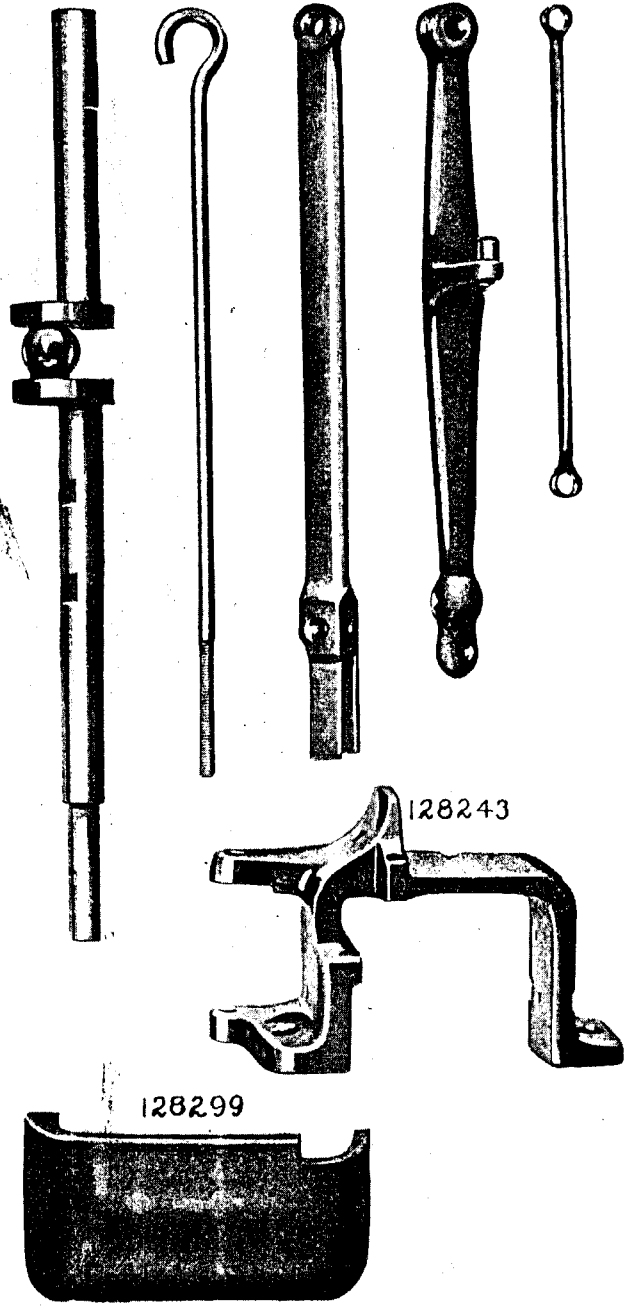
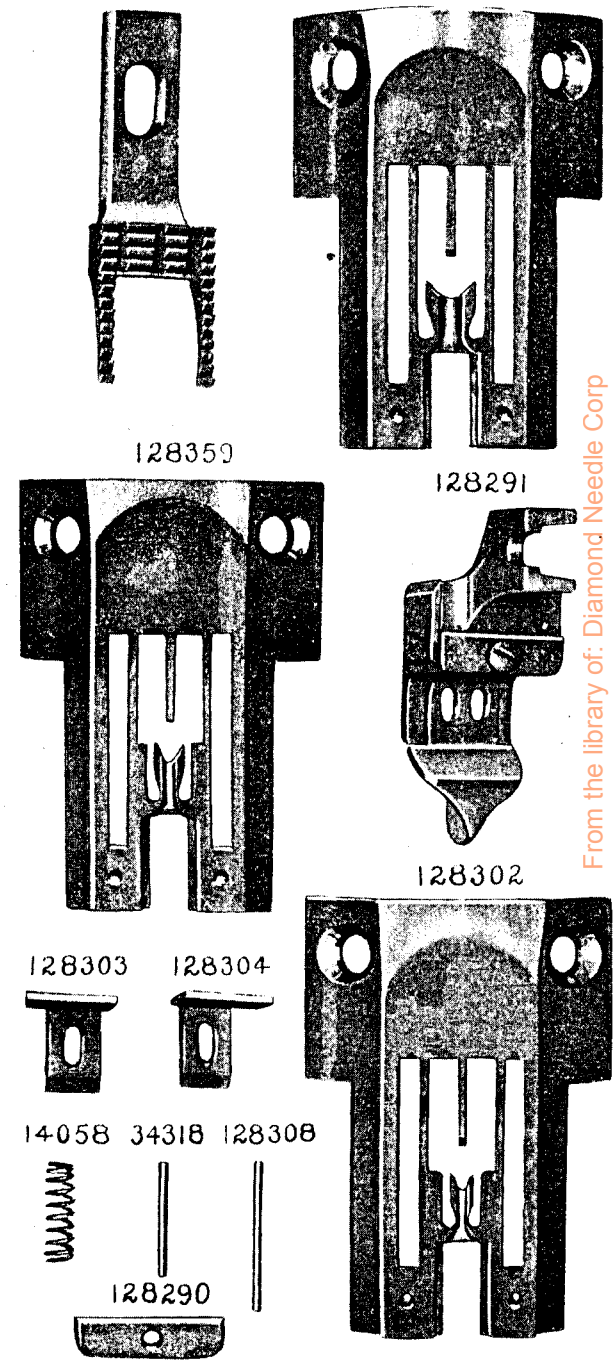


PLATE 9144—FULL SIZE

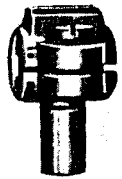
128278 128360



From the library of: Diamond Needle Corp

PLATE 9145—FULL SIZE

128117



54712



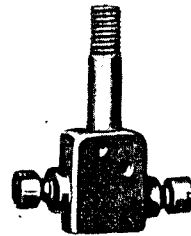
128283



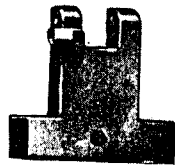
128120



128282



128285



128284



866



1149



1174



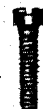
448



128287



51095



51094



207



209



1607



184



50425



1332



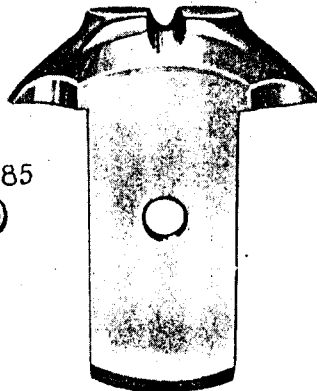
1161



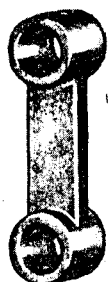
54716



128292



54711



128119



128085



PLATE 9146—FULL SIZE

128065



55084



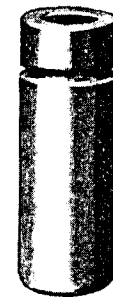
128068



128069



128064



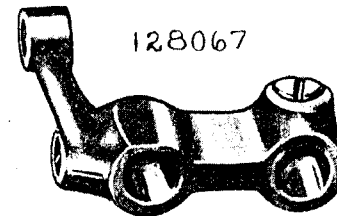
465



440



128067



61121



128066



2049



2269



54722



From the library of: D. C. S. Library of Congress

PLATE 9147-FULL SIZE

54989



54873



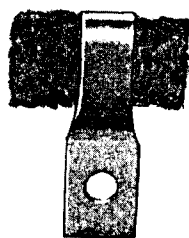
128076



128080



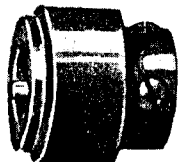
128089



128082



128086



128293



128090



51818



228



128075

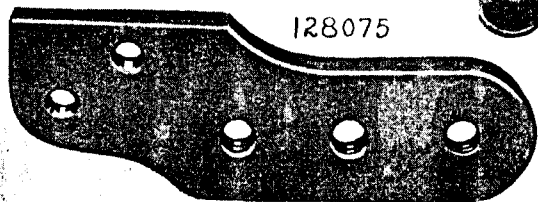
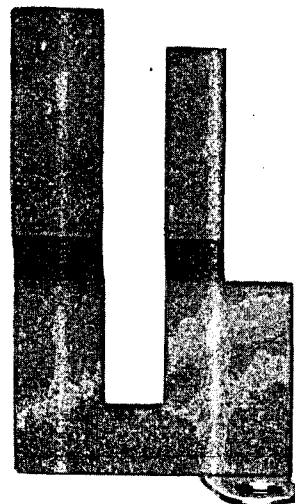
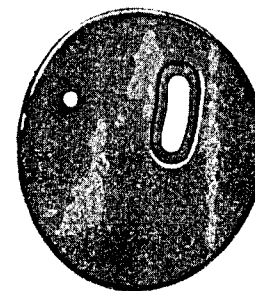


PLATE 9148-FULL SIZE

128238



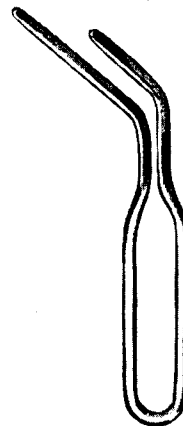
128294



128296



128338



128105



128247



128249



128246



128098



128295



128101



PLATE 9149—FULL SIZE

128108



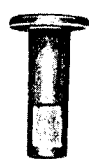
125564



125567



125566



128106



50138



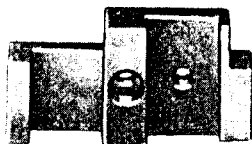
128300



128301



128297



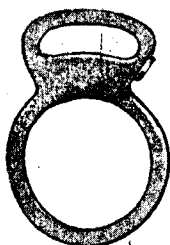
128109



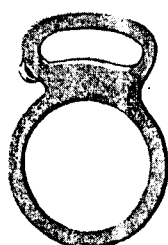
128110



128111



2127



128107

